



P/N 3516010
AR4K #2 TRACK SUPPORT
INSTRUCTION SHEET
26-1/2" TO 35-1/2" ADJUSTABLE HEIGHT

<u>P / N</u>	<u>QTY</u>	<u>REF#</u>	<u>DESCRIPTION</u>
3508017	1		AR4K #2 TRACK SUPPORT - CARTON OF PARTS consisting of:
3508106	2	(1)	AR TRACK SUPPORT BASE TUBE ASSEMBLY
3508108	2	(2)	AR TRACK SUPPORT UPPER TUBE 24" LG.
3508109	4	(3)	AR TRACK SUPT. CLAMP ANGLE
3508112	2	(4)	AR4K TRACK SUPPORT / RAIL DIAG. BRACE 32" LG.
3508024	1		AR4K TRACK SUPPORT - COMMON BUNDLE consisting of:
3508114	1	(5)	AR4K TRACK SUPPORT DIAG. BRACE
3508115	1	(6)	AR4K TRACK SUPPORT CROSS TIE
3508023	1		AR4K TRACK SUPPORT - BAG OF BOLTS consisting of:
5896282	7	(A)	1/2-13 x 1-1/2" HHCS
5896286	2	(B)	1/2-13 x 2-1/2" HHCS
5896287	1	(C)	1/2-13 x 2-3/4" HHCS
5896288	2	(I)	1/2-13 x 3" HHCS
5896293	2	(D)	1/2-13 x 4-1/2" HHCS
5897018	10	(E)	1/2-13 NYLOCK HEX NUT
3508110	4	(F)	AR4K TRACK SUPT. SPACER UPPER
3508105	2	(G)	AR4K TRACK SUPT. SPACER LOWER
5896385	4	(H)	1/2" HD SQUARE NUT
5806400	2	(J)	1/2" SAE FLAT WASHER

1. This product has been supplied with stainless steel hardware to protect against a harsh marine environment and provide outstanding performance. Due to the chemistry and surface condition of stainless steel, there is a natural tendency for the hardware to “gall, lock up, or seize” during assembly. To prevent this from occurring, it is **highly recommended** that the anti-seize supplied in the hardware bag be applied to the mating surfaces of all stainless steel fasteners before assembly. Lubricants containing molybdenum disulfide, graphite, mica or talc may also be used.
2. During installation, the following precautions must be observed when lifting any part of this equipment:
 - a. Be sure of your footing.
 - b. Bend your knees and lift with your legs.
 - c. Hold the equipment section close to your body when lifting.



CAUTION:

DO NOT EXCEED THE MAXIMUM TORQUE RATING ON ALL BOLTS OF 20 FT-LBS.



WARNING:

FAILURE TO APPLY A SUITABLE LUBRICANT TO THE MATING SURFACES OF STAINLESS STEEL THREADED FASTENERS MAY CAUSE GALLING AND/OR SEIZING OF ASSEMBLY.

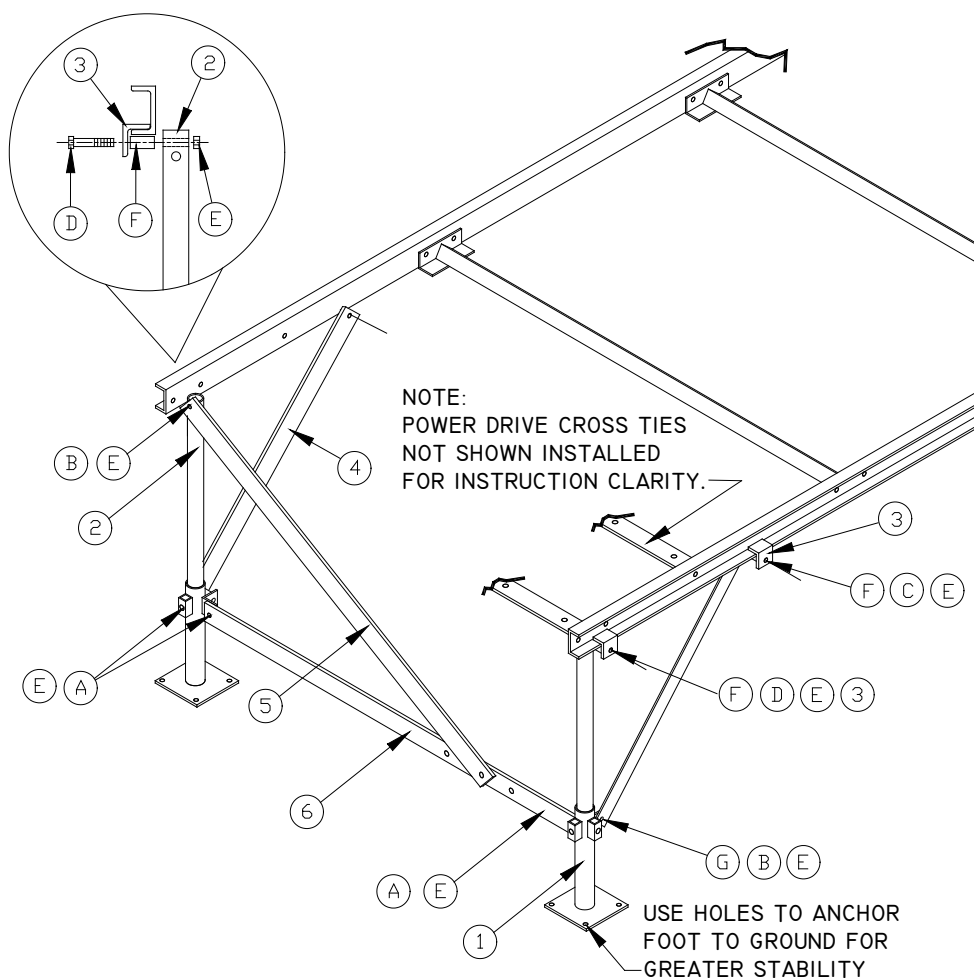

TRACK MUST BE SUPPORTED EVERY 3-1/2 FT.